



PARA LIGHT ELECTRONICS CO., LTD.

11F., No. 8, Jiankang Rd., Zhonghe Dist., New Taipei City 235, Taiwan

Tel: 886-2-2225-3733

Fax: 886-2-2225-4800

E-mail: para@para.com.tw

www.paralighttaiwan.com

DATA SHEET

PART NO.: LT3535UVC-K1PC-SCS

REV: A / X

CUSTOMER'S APPROVAL: _____

DCC: _____

DRAWING NO.: DS-31P-20-0025

DATE: 2020-04-01

PAGE

1

■ Features

- *SIZE: 3.5*3.5*1.6mm
- *Suitable for all SMT assembly and solder process
- * Available on tape and reel
- * Moisture sensitivity level: Level 3
- * RoHS compliant

■ Applications

- * Ultraviolet disinfection
- * Phototherapy
- * Bio- Analysis/ Detection
- * General use

■ Package Dimensions

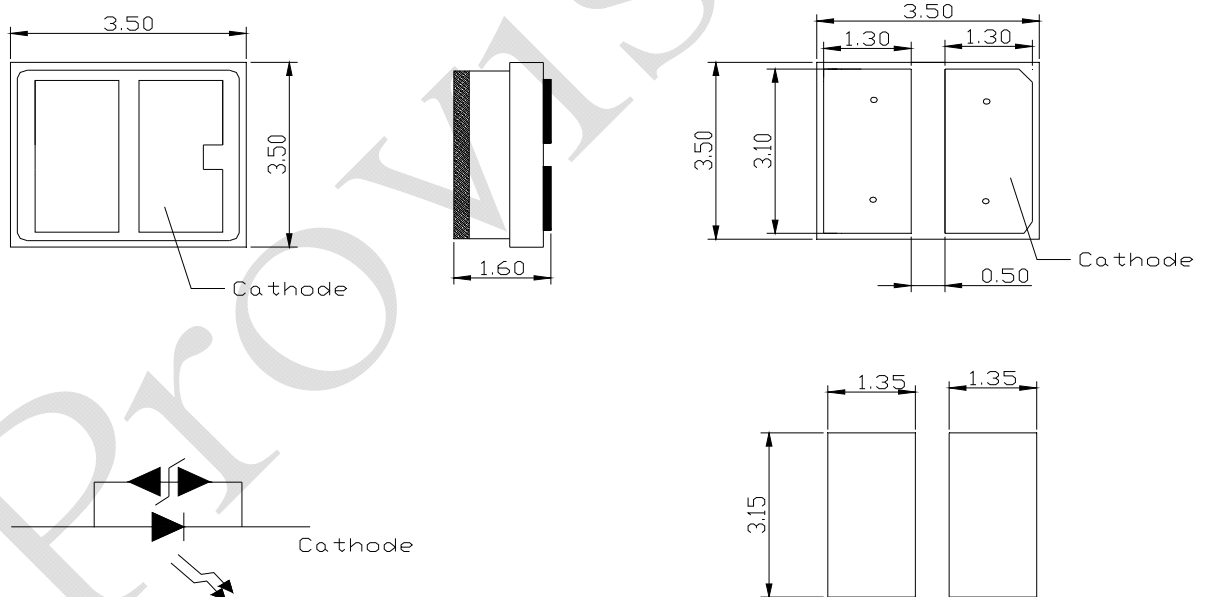

Recommended Pad Design Drawings

Notes:

1. All dimensions are in millimeters.
2. Tolerance is $\pm 0.2\text{mm}$ unless otherwise noted

■ Absolute Maximum Ratings($T_a=25^{\circ}\text{C}$)

Parameter	Symbol	Rating	Units
Power Dissipation	PD	0.25	W
Forward Current	IF	40	mA
Reverse Voltage	VR	5	V
Operating Temperature	Topr	-40~ +55	$^{\circ}\text{C}$
Storage Temperature	Tstg	-40 ~ +80	$^{\circ}\text{C}$
Junction Temperature	Tj	90	$^{\circ}\text{C}$
Thermal Resistance	R _{THJ-S}	15	K/W

Notes:

- 1/10 duty cycle o.1 ms pulse width
2. The above forward voltage measurement allowance tolerance is $\pm 0.1\text{V}$
3. ESD<2000V

■ ELECTRO-OPTICAL CHARACTERISTICS : ($T_a = 25^{\circ}\text{C}$)

Parameter	Symbol	TEST	in	Typ	Max.	Unit
Reverse Current	IR	VR=5V			5	μA
Forward Voltage	VF	IF=40mA		6.0		V
Total Radiant Flux	Φ_e	IF=40mA		4		mW
Peak wavelength	λ_p	IF=40mA		275		nm
Spectral Line Half - Width	$\Delta\lambda$	IF=40mA		10		nm
Half Intensity Angle	$2\theta_{1/2}$	IF=40mA		120		deg

■ Typical Electro-Optical Characteristics

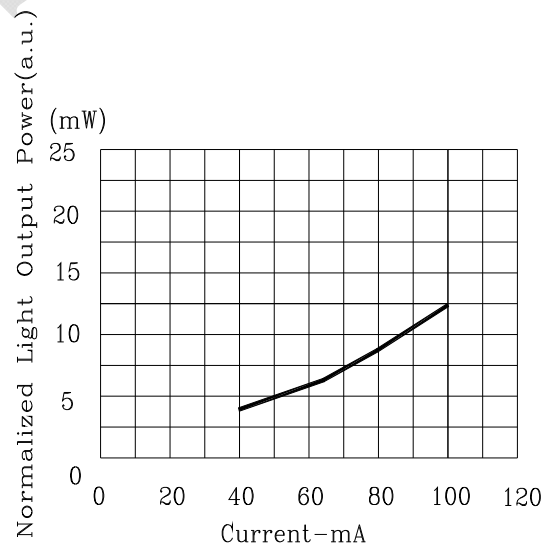
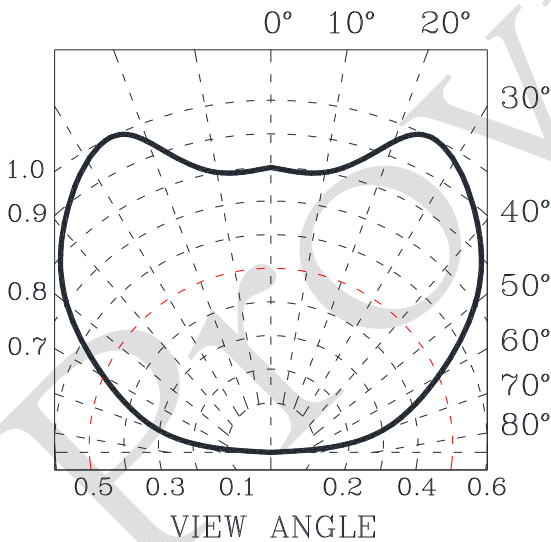
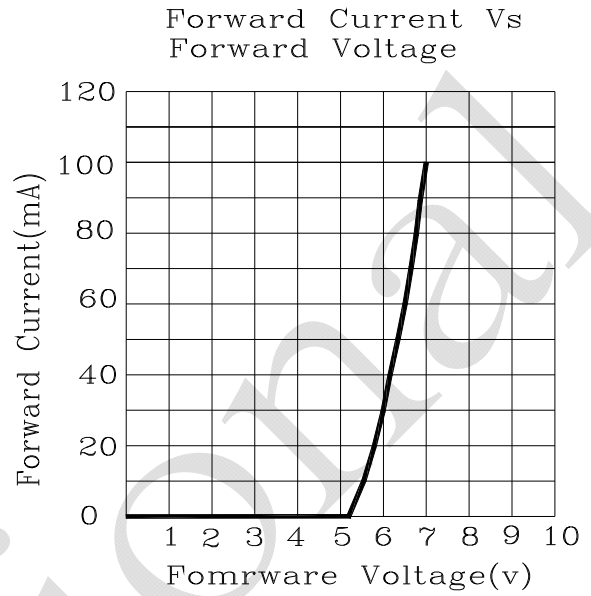
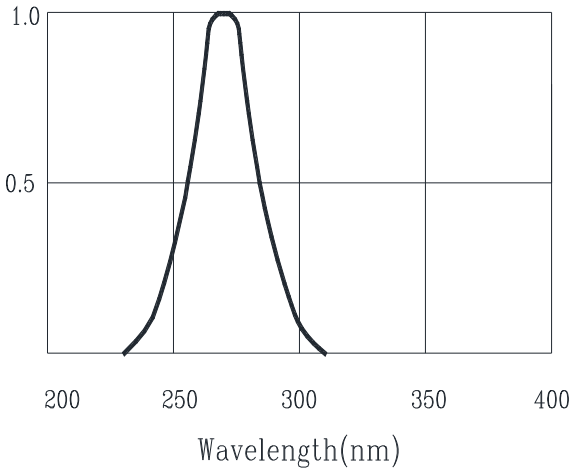

■ Packaging

Carrier tape dimension

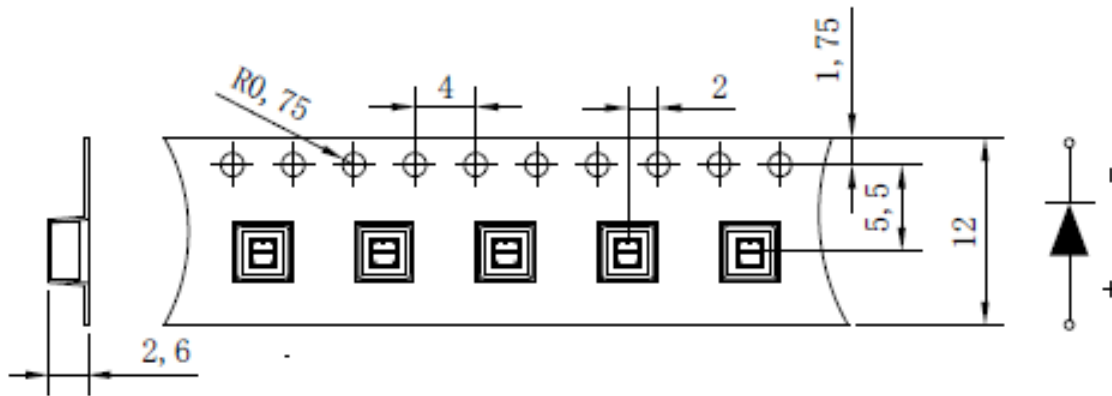

Package: 1000pcs/reel

Reel Dimension

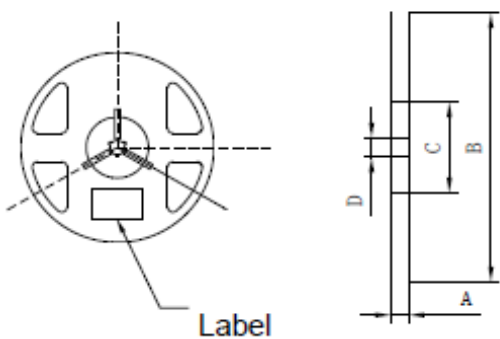

Table 2-1 Reel Dimension

A	12±0.1mm
B	178±1mm
C	60±1mm
D	13.0±0.5mm

Fig.2-2 Reel Dimension

Notes: The tolerances unless mentioned $\pm 0.1\text{mm}$, Unit: mm

Moisture Resistant Packing

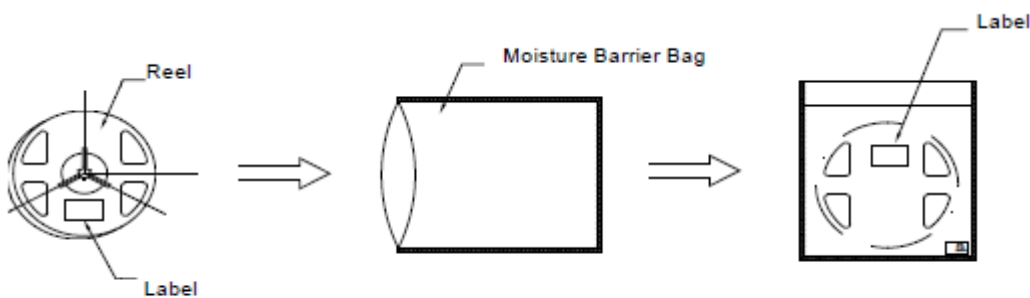

Moisture Resistant Packing Process

SMT Reflow Soldering Instructions

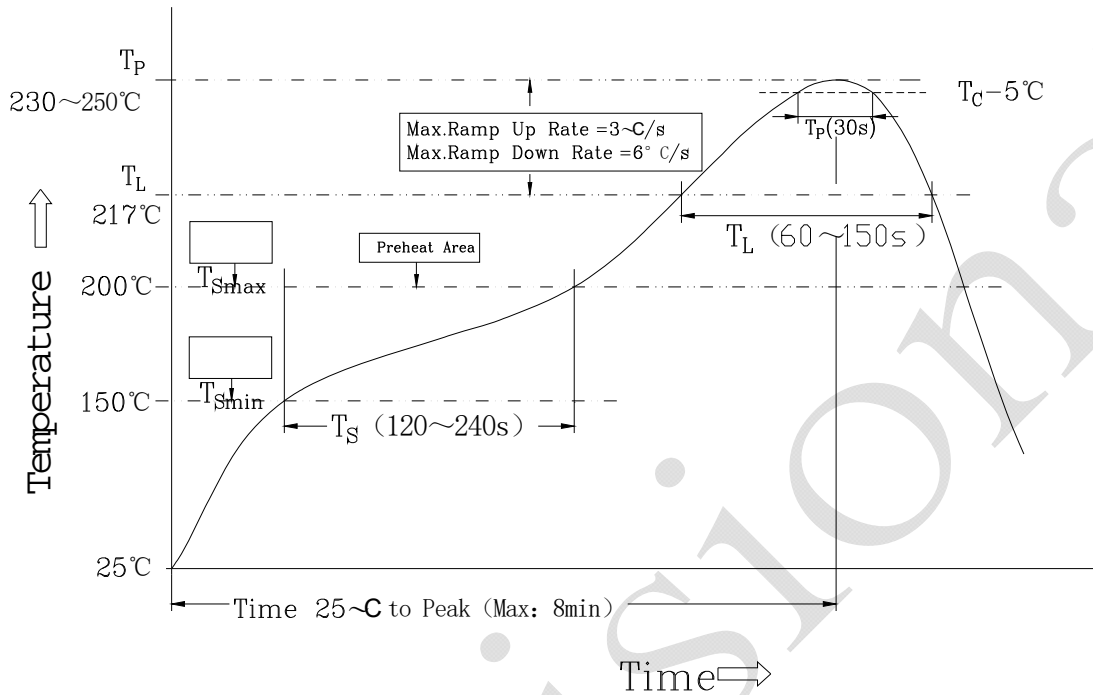

Notes:

1. Reflow soldering should not be done more than two times. If more than 24 hours between the two soldering, LED will be damaged.
2. When soldering, do not put stress on the LEDs during heating.

Soldering iron

1. When do soldering by hand, keep the temperature of iron below less 300C less than 3 seconds
2. Soldering by hand should be done only one time

Repairing

Repairing should not be done after the LEDs have been soldered. When repairing is unavoidable, suitable tools must be used.

It should be confirmed in advance whether the characteristics of LEDs will or not be damaged by repairing.



SURFACE MOUNT DEVICE LED

Part No.: LT3535UVC-K1PC-SCS

REV:A / X

■ Cautions

1. The encapsulated material of the LEDs is silicone. Therefore the LEDs have a soft surface on the top of package. The pressure to the top surface will be impacted on the reliability of the LEDs. Precautions should be taken to avoid the strong pressure on the encapsulated part. So when use the picking up nozzle, the pressure on the silicone resin should be proper.
2. Components should not be mounted on warped(non co plane)portion of PCB.After soldering,do not warp the circuit board.
3. Do not apply mechanical force or excess vibration during the cooling process to normal temperature after soldering. Do not rapidly cool device after soldering.

■ Handling Precautions

Handle the component along the side surface by using forceps or appropriate tools; Do not directly touch or Handle the silicone lens surface, it may damage the internal circuitry.

■ Storage

Conditions		Temperature	Humidity	Time
Storage	Before Opening Aluminum Bag	≤30°C	≤75%	Within 1 Year From Date
	After Opening Aluminum Bag	≤30°C	≤60%	24hours
Baking		60±5°C	-	≥24hours

Notes

1. If the moisture absorbent material(silica gel) has faded away or the LEDs have exceeded the storage time,baking treatment should be performed after unpacking and based on the following condition(65±5)°C for above 24 hours.
2. If the package is flatulence or damaged, please notify the sales staff to assist.
3. Similar to most Solid state devices;LEDs are sensitive to Electric-Static Discharge(ESD)and Electrical Over Stress(EOS).



SURFACE MOUNT DEVICE LED

Part No.: LT3535UVC-K1PC-SCS

REV:A / X

● PART NO. SYSTEM :

L - T 3535 UVC - X X X XX

Single chip : Blank
A1 : Double Dice
A2 : Three Dice A3: Four Dice

E : EMC
P: PPA/PCT
C: ceramics

P: Viewing Angle 120 C: Angle 60
Y: Viewing Angle 150 I: Angle 90

Dice Size:
K:20mil*20mil K1:10mil*20mil
M:22mil N: 28mil O: 30mil R:35mil

IR1:940nm SURFACE MOUNT DEVICE LED
IR4:850nm SURFACE MOUNT DEVICE LED
UVC:200-280nm UVB:280-315nm
UVA:315-400nm

3535 3.5*3.5mm

T :PLCC Top View Type