



## PARA LIGHT ELECTRONICS CO., LTD.

11F., No. 8, Jiankang Rd., Zhonghe Dist., New Taipei City 235, Taiwan

Tel: 886-2-2225-3733

Fax: 886-2-2225-4800

E-mail: [para@para.com.tw](mailto:para@para.com.tw)

[www.paralighttaiwan.com](http://www.paralighttaiwan.com)

# DATA SHEET

PART NO.: LT3535UVC-KCCM-SCS

REV: A / 0

CUSTOMER'S APPROVAL: \_\_\_\_\_

DCC: \_\_\_\_\_

DRAWING NO.: DS-31P-20-0019

DATE: 2020-03-26

PAGE

1

■ Features

- \*SIZE: 3.75\*3.75\*2.85mm
- \*Suitable for all SMT assembly and solder process
- \* Available on tape and reel
- \* Moisture sensitivity level: Level 3
- \* RoHS compliant

■ Applications

- \* Ultraviolet disinfection
- \* Phototherapy
- \* Bio- Analysis/ Detection
- \* General use

■ Package Dimensions

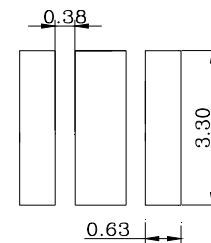
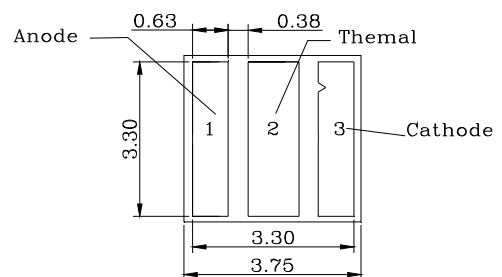
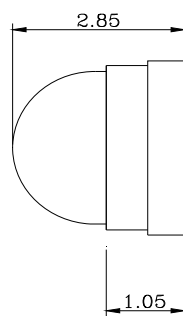
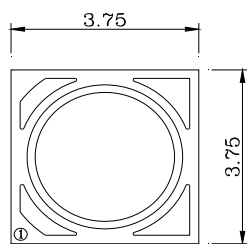

Recommended Pad Design Drawings

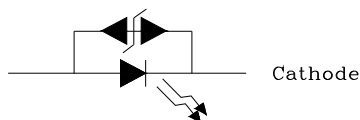

Notes:

1. All dimensions are in millimeters.
2. Tolerance is  $\pm 0.2$ mm unless otherwise noted

**■ Absolute Maximum Ratings**

Parameter	Symbol	Rating	Units
Power Dissipation	PD	0.5	W
Forward Current	IF	100	mA
Reverse Voltage	VR	5	V
Operating Temperature	Topr	-40~ +55	°C
Storage Temperature	Tstg	-40 ~ +80	°C
Junction Temperature	Tj	90	°C
Thermal Resistance	R <sub>THJ-S</sub>	15	K/W

**Notes:**

- 1/10 duty cycle o.1 ms pulse width
2. The above forward voltage measurement allowance tolerance is  $\pm 0.1V$
3. ESD < 2000V

**■ ELECTRO-OPTICAL CHARACTERISTICS : ( Ta = 25° C )**

Parameter	Symbol	TEST	min	Typ	Max.	Unit
Reverse Curren	IR	VR=5V			5	$\mu A$
Forward Voltage	VF	IF=100mA		6.0		V
Peak wavelength	$\lambda_p$	IF=100mA		275		nm
Spectral Line Half - Width	$\Delta\lambda$	IF=100mA		10		nm
Total Radiant Flux	$\Phi_e$	IF=100mA		20		mw
Half Intensity Angle	$2\theta_{1/2}$	IF=100mA		60		deg

■ Typical Electro-Optical Characteristics

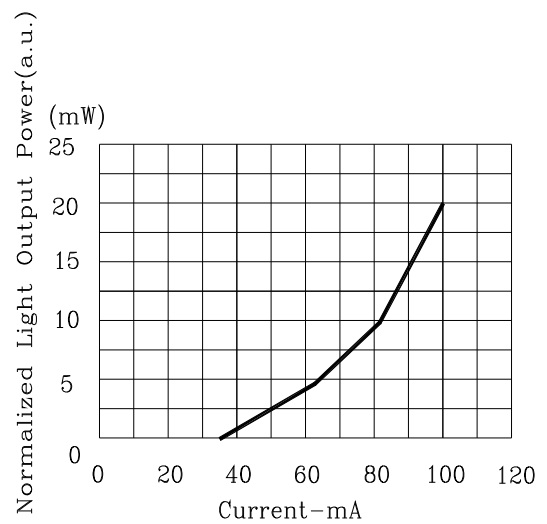
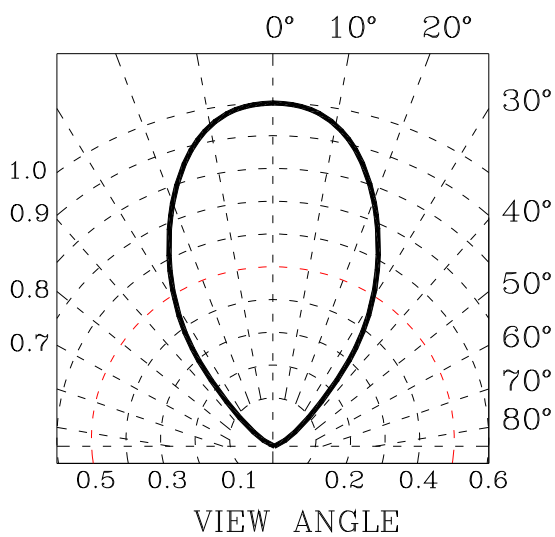
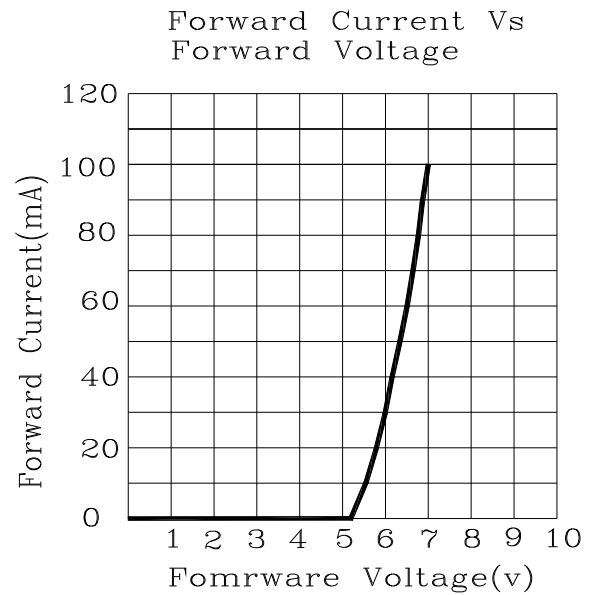
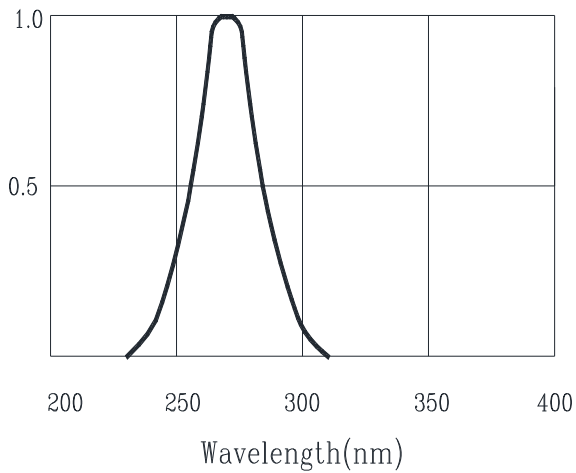

**■ Attachment**

Carrier tape drawings (slightly different batches)

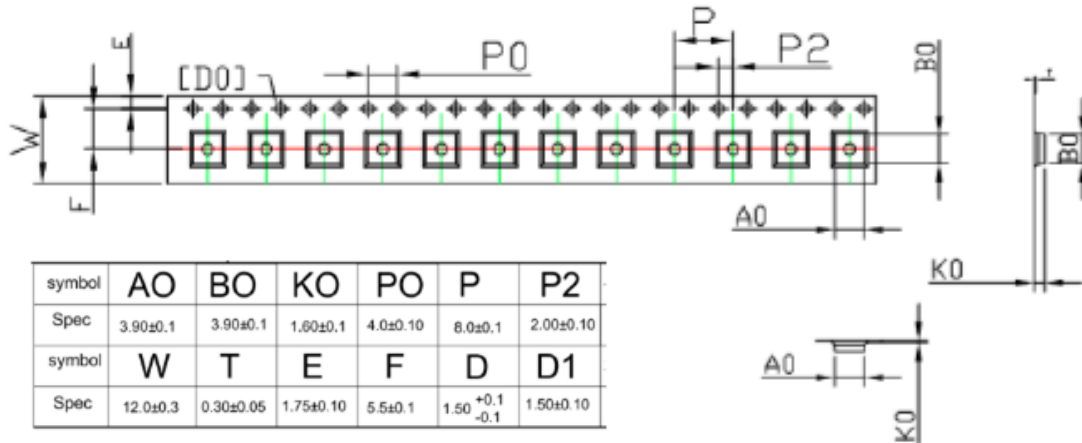

1. 10 Sprocket hole pitch cumulative tolerance is 0.2mm;
2. Carrier camber shall be not more than 1mm per 100mm Through a length of 250mm;
3. Material:Conductive Polyester PS.
4. Package: MIN:200pcs/reel;MAX:2500PCS/reel

**■Cautions on Use**

**Moisture-Proof Package**

The moisture in the SMD package may vaporize and expand during soldering.  
 The moisture can damage the optical characteristics of the UVC-LEDs due to the encapsulation.

**During Usage**

- The LED should avoid direct contact with hazardous materials such as sulfur, chlorine, phthalate, etc.
- The metal parts on the LED can rust when exposed to corrosive gases. Therefore, exposure to corrosive gases must be avoided during operation and storage.
- The silver-plated metal parts also can be affected not only by the corrosive gases emitted inside of the end-products but by the gases penetrated from outside environment.
- Extreme environments such as sudden ambient temperature changes or high humidity that can cause condensation must be avoided.



## SURFACE MOUNT DEVICE LED

Part No.: LT3535UVC-KCCM-SCS

REV:A / 0

### cleaning

- Do not use brushes for cleaning or organic solvents (i.e. Acetone, TCE, etc..) for washing as they may damage the resin of the LEDs.
- Isopropyl Alcohol(IPA) is the recommended solvent for cleaning the LEDs under the following conditions. - Cleaning Condition: IPA, 25°C max. × 60sec max.
- Ultrasonic cleaning is not recommended.
- Pretests should be conducted with the actual cleaning process to validate that the process will not damage the LEDs.

### Thermal Management

- The thermal management is the most important thing of the heat dissipation(cooling) performance for the deep UV(UVC) LED Package.
- The thermal design of the product must be seriously considered even from the beginning stage.
- The co-efficiency between the heat generation and the input power is affected by the thermal resistance of the circuit boards and the density of the LED placements together with other components.
- The deep UV(UVC) LED soldered on a metal PCB with a high thermal conductivity. Or Please combine the deep UV(UVC) LED with a metal PCB and a large volume Heat Sink (Heat Block), a mini(compact / slim)-air or water cooler, etc.
- Please design the LED module or system in customer that the temperature of the LED Package does not exceed the maximum junction temperature( $T_j$ ).

By purchasing the UVC LEDs from the manufacturer, the customer hereby agrees to absolve the manufacture's responsibility of any bodily harm as a result of failure to observe the precautions, warnings and guidelines contained within this Specifications. All assembly workers, observers and bystanders must wear eye and skin protection when the UVC LEDs are energized. Bare eye observation (including through microscopes) and bare-hand handling of a UVC LED in operation is PROHIBITED. UVC light can be easily absorbed, so any oil or other absorbent liquid must NOT be allowed to touch the UVC-LED.

**Reflow soldering profile**

Reflow soldering is the recommended method for assembling LEDs on a circuit board.

